



HAL
open science

Proposal for a new formula to predict the fire resistance of timber connections

Maxime Audebert, Dhionis Dhima, Abdelhamid Bouchaïr

► To cite this version:

Maxime Audebert, Dhionis Dhima, Abdelhamid Bouchaïr. Proposal for a new formula to predict the fire resistance of timber connections. *Engineering Structures*, 2020, 204, pp.110041. 10.1016/j.engstruct.2019.110041 . hal-03060512

HAL Id: hal-03060512

<https://uca.hal.science/hal-03060512v1>

Submitted on 19 May 2023

HAL is a multi-disciplinary open access archive for the deposit and dissemination of scientific research documents, whether they are published or not. The documents may come from teaching and research institutions in France or abroad, or from public or private research centers.

L'archive ouverte pluridisciplinaire **HAL**, est destinée au dépôt et à la diffusion de documents scientifiques de niveau recherche, publiés ou non, émanant des établissements d'enseignement et de recherche français ou étrangers, des laboratoires publics ou privés.



Distributed under a Creative Commons Attribution - NonCommercial - NoDerivatives 4.0 International License

Proposal for a new formula to predict the fire resistance of timber connections

M. Audebert^{a,*}, D. Dhima^b, A. Bouchair^c

a Université de Lyon, Ecole Nationale d'Ingénieur de Saint-Etienne, Laboratoire de Tribologie et Dynamique des Systèmes (LTDS), UMR 5513, 58 rue Jean Parot, 42023 Saint-Etienne Cedex 2, France

b CSTB, Centre Scientifique et Technique du Bâtiment, Marne-la-Vallée, France

c Université Clermont Auvergne, CNRS, SIGMA Clermont, Institut Pascal, F-63000 Clermont-Ferrand, France

A large experimental and numerical program based on fire tests of timber connections under various mechanical loadings was performed in France since 1999. Numerical models, simulating the thermomechanical behavior of these tested connections were developed and validated on the basis of experimental results. The developed model is sufficiently relevant to realize parametrical studies on timber connections. Then, considering the four main parameters influencing the fire resistance of the connections (type and diameter of fasteners, thickness of timber members and load ratio), the model is used to analyze the combined influence of these factors and to realize a calibration based on the experimental design approach. The commonly used thicknesses of timber elements and diameters of fastener are chosen in the study. The experimental design approach based on numerical results considers the main loading cases in timber connections. It is used to propose a simplified formula to predict the fire resistance of timber connections loaded in tension parallel to grain, perpendicular to grain or bending. The proposed formula is then applied to all the available experimental results to check its accuracy.

1. Introduction

In timber constructions, the connections are often the weakest among the various structural components. In fire situation as well as in normal condition, they govern the bearing capacity and the mechanical behavior of the structure. Due to their complex geometrical, physical and material configurations, the behavior of the connections in fire is one of the more difficult to predict. Although experimental and numerical studies exist in the literature [1–3] and the progress made by EN1995-1-2 [4], large limitations related to the design of timber connections remains due to the limited number of experimental and numerical results [5]. Thus, the current design rules are of limited application with unsatisfactory accuracy, and may even overestimate the fire resistance of the connections [6].

In order to increase the data and improve the knowledge of the thermomechanical behavior of timber connections exposed to fire, experimental programs have been carried out since 1999 in some countries [1,7–15]. In fact, the development of generalized models requires the combination of research based on both experimental results, given by full scale tests, and analytical models or sophisticated finite element models validated on the tests. Complying with the actual architectural

trends and high strength requirements the tested connections concerned mainly timber-to-timber or steel-to-timber connections with bolts and dowels, in double or multiple shear plane subjected to various loading types. The experimental results improved the understanding of the complex mechanical behavior of timber connections exposed to fire and gave the possibility to identify the most influential geometrical and mechanical parameters. Besides, the measured values were used to calibrate and validate numerical modelling approaches.

Laplanche [13] and Audebert et al [6,7,16] initiated vast numerical studies in order to simulate as precisely as possible the thermomechanical behavior of timber connections exposed to fire. The developed numerical model was validated by comparison with experimental results. It represents well the fire behavior of timber connections and gives fire resistance durations in good accordance with the experimental values. Once the numerical model validated on a large number of tests, it is applied to different configurations of connections to provide data for the experimental design approach in order to propose a new simplified formula that can be used in safe and economic practice of fire engineering for timber connections. This new formula could be used as a general tool to predict the fire resistance of large variety of timber connections.

* Corresponding author.

E-mail address: maxime.audebert@enise.fr (M. Audebert).

In this paper, the main conclusions drawn from the various experimental programs carried out during the last fifteen years are first presented in order to identify the main parameters influencing the fire behavior of timber connections. These key parameters are then used as input variables to determine the factors to be calibrated in the development of the experimental design based on numerical results. Then the main assumptions of the numerical model are exposed, and its results compared to those obtained from experiments. The experimental design based on numerical results is then presented and a polynomial response obtained. This polynomial response is used to propose a simple formula to predict the fire resistance duration of timber connections. Finally, this new formula is applied to different configurations of connections tested recently in different countries. The comparison of the results and the accuracy of the proposed formula are discussed.

2. Experimental results

Since 1999, several experimental research programs have been carried out in different countries to study the fire resistance of timber connections [1,7–15]. These research works were carried out in order to analyze the complex thermomechanical behavior of timber connections and to identify the geometric and mechanical parameters that have a significant influence on their behaviour in fire. The tests carried out mainly concern timber-to-timber and steel-to-timber connections in double shear loaded in tension parallel to grain. Examples of the geometrical configurations tested are shown in Fig. 1. The detailed dimensions of the specimens are given in the references. The specimens tested in Switzerland in 2004 concern steel-to-timber connections with multiple shear planes (Fig. 2). Most recently, steel-to-timber

connections have been tested in bending or in tension with angles to the grain of 45° and 90° (Fig. 3). Those tests made it possible to observe the influence of the angle of loading on the fire resistance of the connections [7,16].

The parameters that have been analyzed during these tests were the fastener type (dowel or bolt) and diameter, the thickness of the timber members, the load ratio in fire situation, the distances between fasteners, the edge distances and the use of a protection on timber members or on steel fasteners. The main conclusions drawn from these observations are presented in the following sections.

2.1. Timber members thicknesses

It can be clearly seen from all the available experimental results that the thickness of the timber members is the parameter that most governs the fire behavior of the connections. Thus, for a strictly identical connection, 20 mm increasing in the thickness of the timber members makes it possible to increase the fire resistance duration by 30% to more than 70% depending mainly on the load ratio [7]. Thus, for low values of load ratio, the increase in fire resistance appears to be greater. The thickness of the timber elements is therefore the main factor that determines the fire resistance of the connections.

2.2. Effect of load ratio

Low values of load ratio in fire allow to obtain high fire resistance durations. Thus, reducing the load ratio of the tested connections from 30 to 10% lead to the increase of fire resistance by about 10 to 20 min for the specimens loaded in tension parallel to grain. In the case of

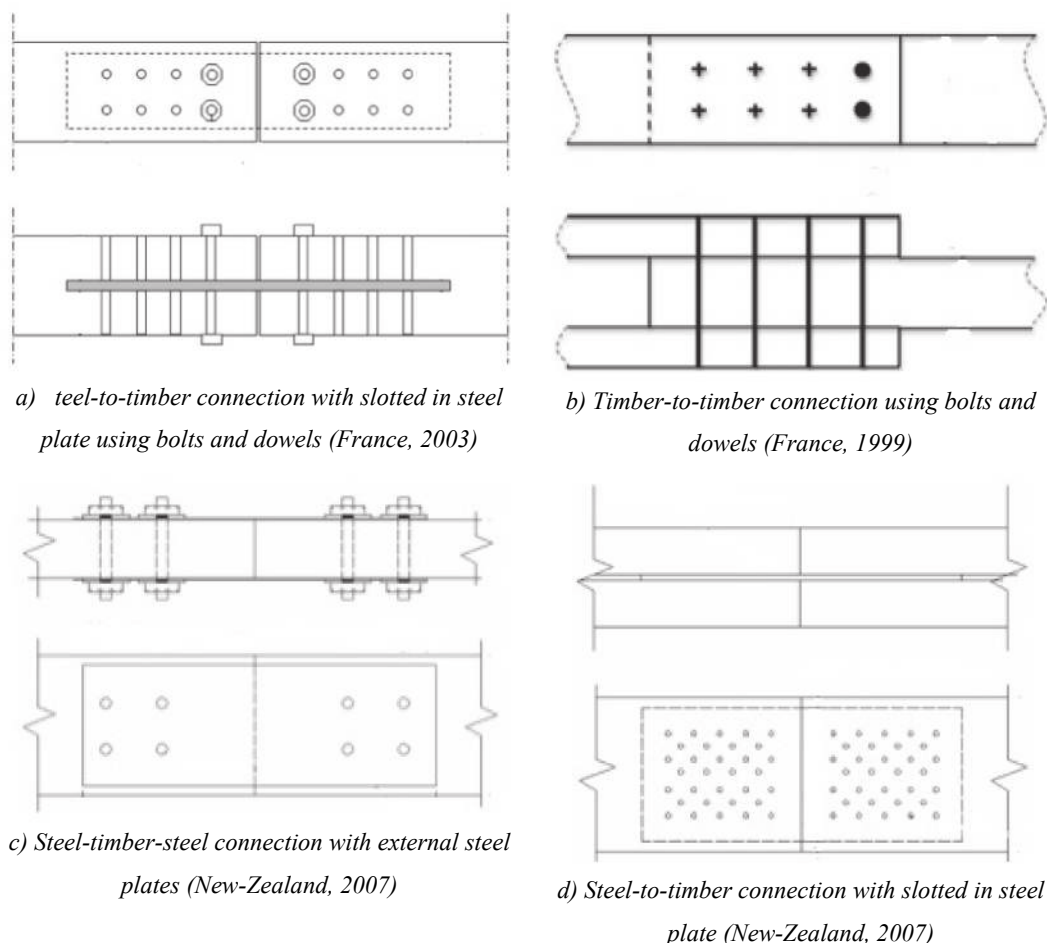

Fig. 1. Examples of tested specimens in tension parallel to grain.

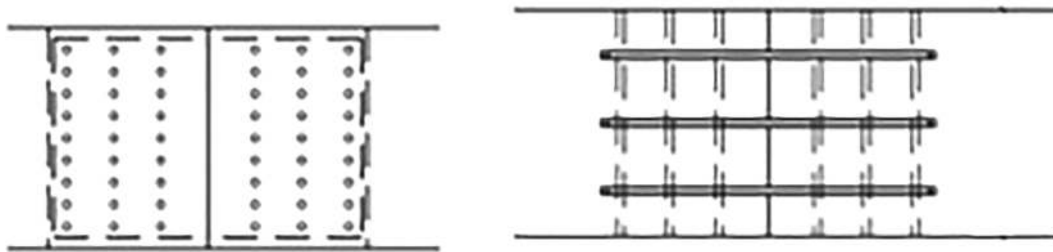
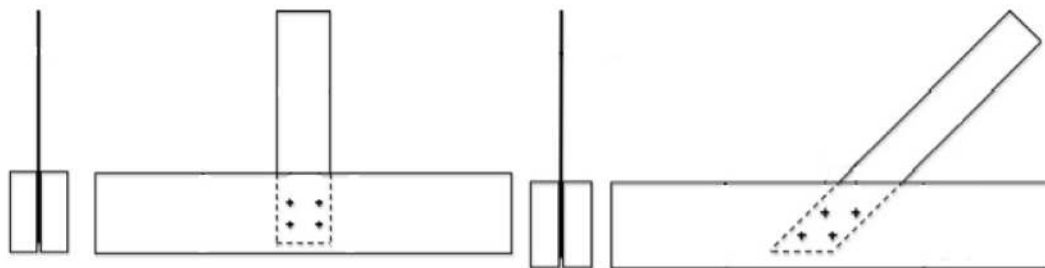
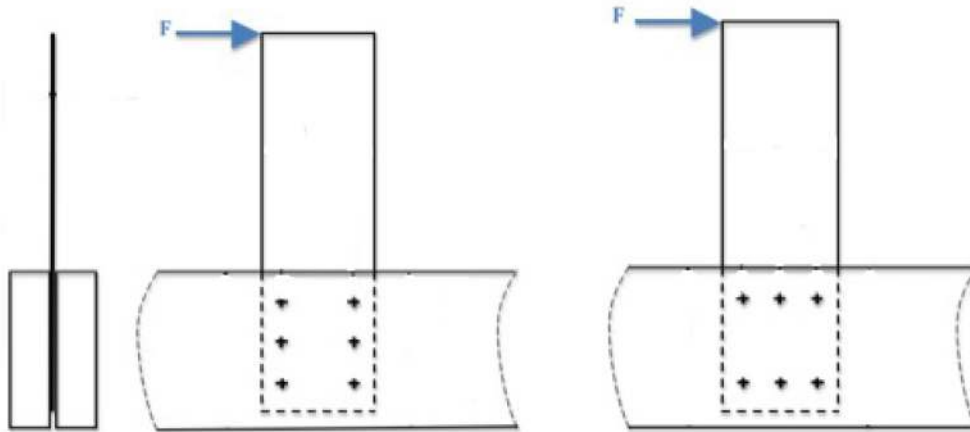

Fig. 2. Steel-to-timber connections with multiple shear planes in tension parallel-to-grain (Switzerland, 2004).



a) Steel-to-timber connection in tension perpendicular-to-grain (France, 2010)

b) Steel-to-timber connection in tension with an angle the grain of 45° (France, 2010)



c) Steel-to-timber connection tested in bending (France, 2010)

Fig. 3. Steel-to-timber connections loaded with angle to grain or bending (France, 2010).

connections loaded with an angle to grain, the fire resistance increases even more significantly (29 min on average). For specimens in bending, the increase is about 27 min.

The effect of the load ratio is more significant for specimens with thicker timber members [7,15]. Thus, the load ratio parameter interacts with the timber member thicknesses.

2.3. Effect of the angle of load

The experimental program carried out in France in 2010 [7], on steel-to-timber connections loaded in tension with an angle-to-grain, showed high values of fire resistance. The tests show that, with equivalent fasteners diameters and timber thicknesses, the connections tested in tension with an angle to grain of 45° present a fire resistance duration lower than that of the connections tested with an angle to grain of 90°. The experimental results on steel-to-timber connections loaded in tension parallel to grain with dimensions close to those of the connections loaded with an angle to grain confirm this observation: the

fire resistance of the connections decreases as the load angle tends to 0°. As for timber connections loaded in tension with an angle to grain, high fire resistances, close to one hour, were obtained for timber connections in bending [7].

This experimental observation appears against intuitive because of the low mechanical characteristics of timber in the direction perpendicular to grain. Nevertheless, this phenomenon could be explained by the load ratio applied in fire situation, which is lower in tension perpendicular-to-grain. This phenomenon can be explained by the real load ratio applied in fire tests. The connections loaded in tension with an angle to grain of 90° have a lower value of resistance in normal conditions which is used as reference to define the load to be applied in fire.

The main conclusion drawn from this experimental program is that there is a predominant loading case in the design of the timber connections in fire situation. For equivalent timber thicknesses and fasteners diameters, connections loaded in tension parallel to grain showed lower fire resistance durations than those obtained for other

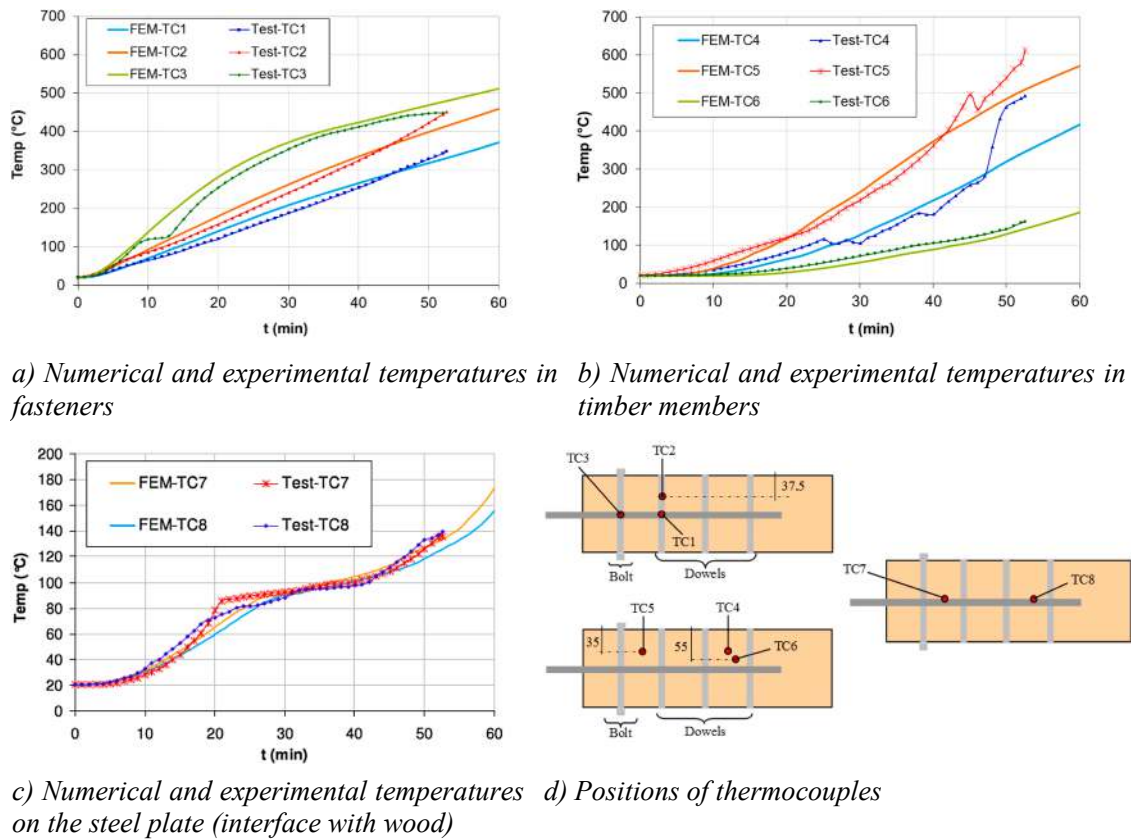

Fig 4. Comparisons between numerical and experimental temperatures for various connections [6].

loading cases. Therefore, the tension parallel to grain appears to be the most unfavourable in fire situation. It would mean that in fire resistance, a connection configuration designed in tension parallel-to-grain using the recommendations of Eurocode 5, would satisfy the strength criterion for all other loading types.

2.4. Type and diameter of the fasteners

The experimental results show that the tested specimens made only with bolts have significantly lower fire resistance than those made with dowels or with a combination of bolts and dowels. Thus, the bolted connections performed fire resistance durations lower than 30 min. This phenomenon is explained by the high thermal conductivity of steel and the greater heating of the bolts due to the presence of bolt head, nuts and washers that increase the surface area directly exposed to thermal action. Therefore, the use of bolt plays a negative role on the fire resistance of timber connections. The influence of the ratio bolts/dowels on the fire resistance of timber connections was studied using a numerical model to confirm the observed experimental results [6]. It appears that the presence of one bolt for four fasteners reduces by about 15% the fire resistance comparing to a connection assembled only with dowels.

The fastener diameter increase does not improve the fire resistance of the connections. Indeed, for equivalent thicknesses of timber members, the use of fasteners with diameters 12, 16 or 20 mm does not change the fire resistance of the tested connections [7]. The increase of the fasteners diameter accordingly reduces the load ratio in fire and thus improves the fire performance of the connections. The diameter of the fasteners seems to have an influence only on the failure mode of the connections in shear, with a more or less important yielding of the fasteners [7,15]. Besides, the influence of the number of fasteners is insignificant [7,11,15].

3. Numerical modelling approach

The experimental results obtained with the French experimental research program [1,7,8,12,13] were used to calibrate and validate a numerical model simulating the thermo-mechanical behaviour of the tested connections. The validation is based on the comparison between the calculated and the measured values of temperatures, charring rates and fire duration resistances. In this section, the main assumptions considered in the numerical modelling of the tested connections are presented. The model is developed in two steps using the MSC-MARC software [17].

3.1. Heat transfer modelling

The numerical simulations of heat transfer within the connections are performed considering the evolutions of the thermo-physical properties such as the thermal conductivity and the specific heat of steel and wood materials. It should be noted that the time-temperature evolution, inside the connections, is obtained by solving the transient equation based on the conservation of thermal energy, while the complex phenomenon of mass transfer is not represented, but apparent values of specific heat and thermal conductivity are used. The thermophysical properties of steel are taken from Eurocode 3 [18] and those of timber are chosen with a sensitivity analysis [6]. This sensitivity analysis showed that for wood components the best combination of thermal conductivity and specific heat, giving the best numerical results is obtained using the thermal conductivity values proposed by Janssens [19] and the specific heat values proposed by Fredlund [20] and Janssens. To take into account the presence of the water vapor contained in the wood that migrated and condensed at the front of metal plate, playing the role of barrier, a peak of specific heat to 100 kJ/(kg °K) is taken into account in the model, for a layer of wood near the interface between the wood and the metal plate.

For the thermal calculations, it is assumed that all the interfaces between the components are in perfect contact with continuous meshing. The faces in contact with the hot gases are subjected to thermal actions with an evolution according to the ISO R834 curve.

The heat transfer model was validated by comparison of its calculated values with the experimental charring rates and the temperatures measured by the thermocouples in some locations at different depths inside the connections. Examples of these comparisons are given in Fig. 4. The results obtained by the numerical model were in good agreement with the experimental values [7]. The heat transfer model represents well the temperature fields inside the connections.

3.2. Mechanical model in normal conditions of temperature

In the mechanical modelling, steel of plates and dowels was considered with isotropic elastic-plastic behavior according to the von-Mises yield criterion. The mechanical behavior of wood was considered with transverse isotropy assuming the same properties of the material for radial and tangential directions. The evolution of the plastic deformations in wood material was taken into account using the 3D Hill yield criterion that describes the anisotropic plasticity. In the cases of connections loaded in tension with angle to grain, Hill yield criterion is associated to Tsai-Wu failure criterion in order to take into account the dissymmetric behavior of material in tension and compression. Hill criterion was chosen for these simulations because it represents well the evolution of plasticity in compression. These constitutive relations of mechanical behavior were validated by numerical simulation of the connections in normal conditions of temperature. The comparison of measured and simulated load-slip curves showed that the chosen

mechanical model was accurate to represent the general trends of the experimental curves, whatever the load case studied (Fig. 5). It should be noted that for the connections in bending, the model fails to represent the high plastic deformations observed during tests, because of some difficulties of convergence on large deformations. In fact, the tests were stopped, not at the connection failure, but when the loading reached a plateau with high displacements and the impossibility to maintain the load.

3.3. Thermomechanical model

The thermo-mechanical analysis of the connections needs to take into account the evolution of mechanical properties of materials depending on temperatures. This evolution was considered using reduction coefficients of the mechanical properties depending on the temperature at each point of integration in the finite elements of the mechanical model. The reduction factors used were those provided by the Eurocodes EN1993-1-2 for steel and EN1995-1-2 for timber.

The 3D-FEM mechanical model takes into account the material and geometrical nonlinearities, and the contact evolutions at the interfaces between the components of the connections. Thus, the meshing of the mechanical model is discontinuous at the contact zones and differs from that of the heat transfer. Then a procedure has been developed to make the transposition of the temperatures calculated with thermal meshing to the mechanical meshing. This procedure gives the possibility to adapt the meshing density to the zones where the physical or the mechanical phenomena exhibit the higher gradients [6,7,16].

The thermo-mechanical model was validated by comparison with the experimental results. The comparison concerns mainly the

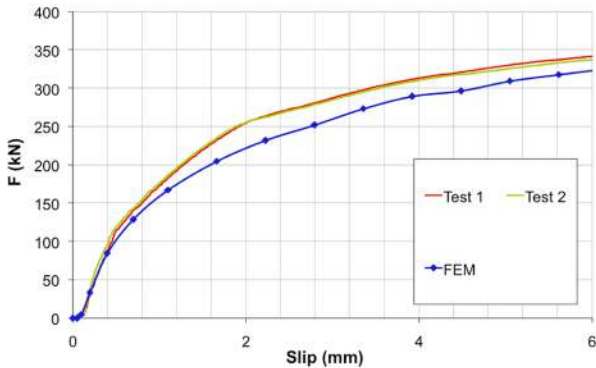

a) Connection loaded in tension parallel to grain (Fig. 1a)

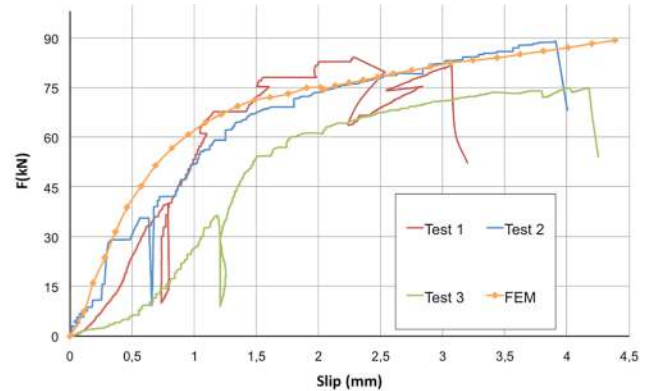

b) Connection loaded in tension perpendicular to grain (Fig. 3a)

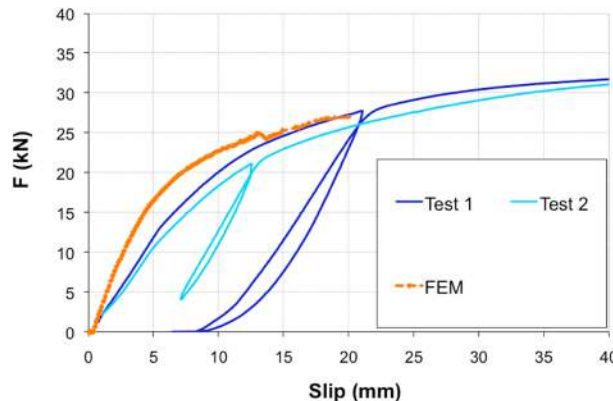

c) Connection loaded in bending (Fig. 3c)

Fig 5. Comparisons of numerical and experimental load-slip curves (normal conditions of temperature) [7,16].

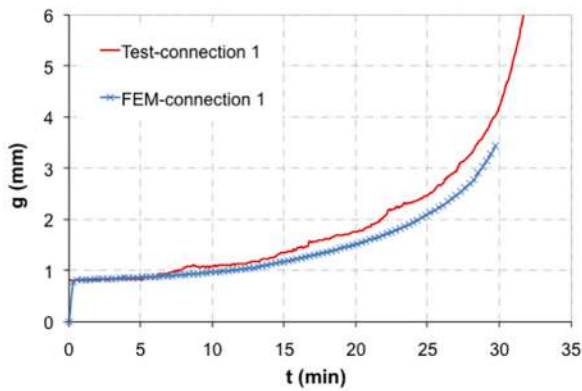

a) steel-to-timber connection in tension parallel to grain (Fig. 1a)

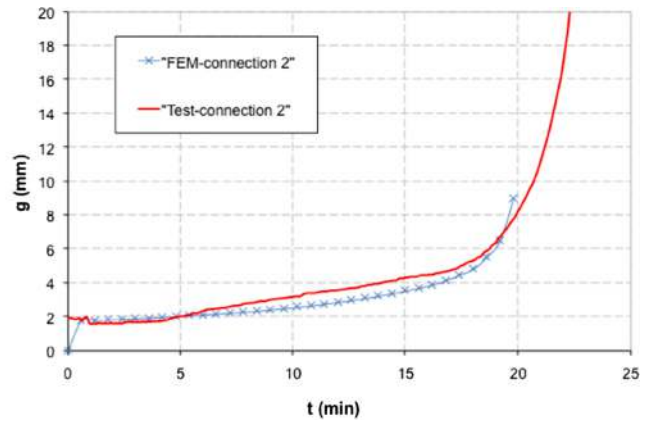

b) Timber-to-timber connection in tension parallel to grain (Fig. 1b)

Fig. 6. Examples of comparison of numerical and experimental slip-time curves [6,21].



Fig. 7. Large plastic deformations observed after a fire test of steel-to-timber connection in bending (Fig. 3c).

evolutions of the connection slip versus the time of exposure to fire. Good agreements were obtained between the numerical and the experimental curves (examples in Fig. 6). In tests, the mechanical load is constant, and the specimen exposed to fire. When, the displacement is accelerated, the fire resistance is considered reached. The numerical slip-time curves were used to define the calculated fire resistance times. The fire resistance times obtained by the numerical model have been always lower than those obtained from the experimental tests with a mean relative error of about 15%. These fire resistance times are obtained considering the intersection of the two tangents to the initial and final stages of the load-slip curves. The calculation is in general stopped when the process is non-convergent but the final load-slip curve is checked to guarantee that the displacement of the specimen was accelerated confirming that the mechanical capacity is reached (Fig. 6). For some configurations of connections (mainly in bending), large plastic deformations were observed during the tests (with significant embedment of the fasteners in the holes – see Fig. 7). These deformations do not mechanically represent the fracture of the connection and are complex to simulate numerically (large deformations).

So, the numerical model represents well the linear and the non-linear phases of the experimental slip-time curves, but the fire resistance value given by the numerical model doesn't represent the ultimate stage of failure, when the displacements are very significant. Experimentally, it appears that the connections performed few minutes of additional resistance after the initiation of failure but it is not relevant, in a safe design approach, to perform the numerical model to represent this ultimate stage of failure. It can be noted here that the fire

resistance value obtained experimentally does not represent the mechanical fracture of the connection but depends on the experimental setup (the capacity of the jacks). Indeed, the failure is experimentally determined when it becomes impossible to maintain the applied load. The numerical model represents safely the behavior of the connections exposed to fire, with good agreements between the experimental and numerical curves.

The examples illustrated above show that the connections tested cover a large variety of configurations and load conditions. The examples of comparison between the experimental results and those given by the FEM confirm that the developed numerical model can be considered sufficiently relevant to be used to generate data for an experimental design approach based on numerical results. The details about the tested configurations, the experimental data and the finite element model can be obtained in the publications by Audebert et al. listed in the bibliography.

4. Experimental design based on numerical results and formula proposal

The experimental results showed that the fire resistance of the connections is influenced by three main parameters, which are the fastener diameter associated to the slenderness (ratio length to diameter), the thickness of timber members and the load ratio. These parameters interact with each other. These three parameters represent the three factors of which the combined influence has been studied in the experimental design based on numerical results. Other most influencing parameter is the type of fasteners used: dowel or bolt. In the practice, bolts are commonly used in association with dowels to connect timber elements. Their function is to prevent the separation of the connected members. The use of one bolt with three dowels (for four fasteners) is common and this distribution is mentioned in Eurocode 5. The influence of this ratio bolts/dowels on the fire resistance of timber connections was numerically studied [6]. It appears that the presence of one bolt for four fasteners reduces by about 15% the fire resistance comparing to a connection assembled only with dowels. Fig. 8 shows the calculated load-slip curves obtained for two similar connections: the first is assembled with 2 rows of 4 dowels and the second is assembled with 2 rows of 3 dowels and 1 bolt.

The experimental design was realized for only dowelled steel-to-timber connections with double shear planes. The connections tested in France in 2003 has been used as a reference for the experimental design approach because the N_u (ultimate failure loads) of these connections have been obtained from tests in normal conditions, and consequently, the load ratios applied in fire conditions were precisely known. The

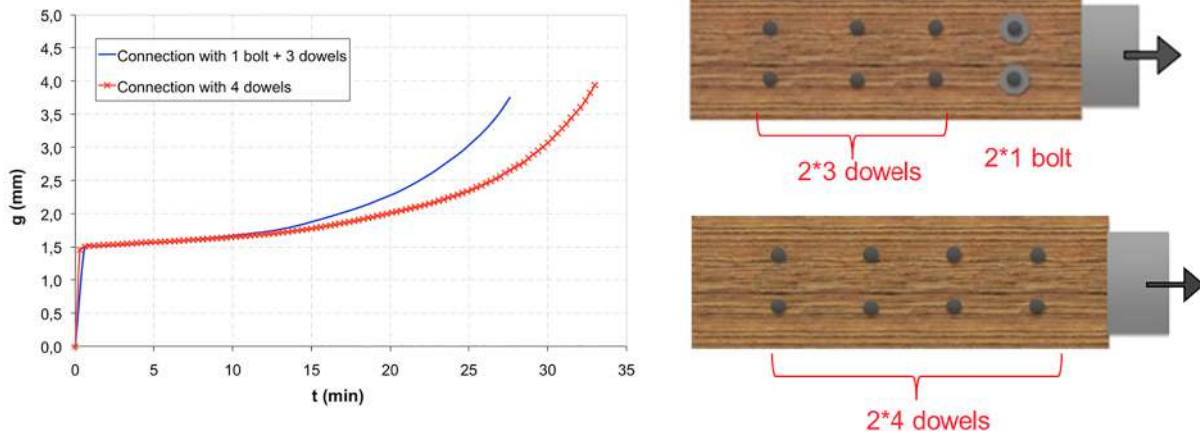

Fig. 8. Influence of the presence of one bolt (per row) on the slip-time curves of steel-timber connection in fire [7].

decrease of fire resistance generated by a bolt under fire exposure can be estimated thereafter by the introduction of a specific reduction coefficient. The reference connection chosen for the experimental design based on numerical model was loaded in tension parallel to grain. This loading case is predominant in the design of the connection for fire situation (see Section 2.4).

The geometrical configuration studied is presented in Fig. 9. The number of dowels was kept constant for all the studied configurations (2×4 dowels). The experimental researches showed that the number of fasteners was insignificant on the fire resistance of connections as it is based on a load ratio defined from the resistance in normal conditions. The spacings and edge distances for each geometrical configuration were chosen in accordance with EN1995-1-2.

Three different values were considered for the diameter of dowels (12, 16 and 20 mm) to cover the common fastener diameters used in timber structures. Six values of timber member thickness were chosen to take into account the common available thicknesses (from 55 to 160 mm). Two values were considered for the load ratio η (10 and 30% of N_u). For each configuration, the reference value of failure load in normal condition N_u (20 °C) was determined from the numerical mechanical model under normal conditions (load-slip curves). This model gives estimations of the experimental load-carrying capacity of the connections in normal conditions better than those obtained from the Eurocode 5 formula (EN1995-1-1) [6].

These values retained for the variable factors of the experimental design defined the maximal and minimal borders of the considered parameters, frequently used in timber construction. To take into account the variable parameters (3 diameters, 6 thicknesses of timber and 2 load ratio), 36 configurations were simulated to obtain a complete

factorial design considering the influence of each parameter. Table 1 summarizes the predicted fire resistance durations ($t_{fi,sim}$) obtained from 3D finite element simulation. For each configuration, the simulation concerned the mechanical analysis to obtain the load bearing capacity in normal conditions (see Section 3.2). It was followed by the thermo-mechanical analysis as described in Section 3.3 to obtain the fire resistance.

From the calculated values of fire resistance, a polynomial function is fitted according to the three selected parameters, using the least squares method on Matlab. In this polynomial function, the interactions $d \cdot \eta$ and $t_1 \cdot \eta$ are highlighted and a logarithmic relation between fire resistance duration and load ratio has been identified. Indeed, this relation corresponds to the tendency observed with the experiments. Then, the polynomial function of Equation (1) is chosen, where d is the bolt (or dowel) diameter, t_1 is the timber member thickness and η the load ratio (load in fire/resistance in normal conditions). Thus, the calculated value of fire resistance, called $t_{fi,calc}$ in tables, can be obtained by Eq. (1).

$$\tilde{t}_{fi} = 31.92 - 1.79d + 1.03t_1 - 7.51 \cdot \ln(\eta) + 0.003d \cdot t_1 + 0.49d \cdot \ln(\eta) - 0.24 t_1 \cdot \ln(\eta) \quad (1)$$

Considering the fire resistance of the 36 calculated connections, the equation (Eq. (1)) gives a mean relative error equal to 7.85% (Eq. (2)).

$$\| \varepsilon \| = \frac{\| t_{fi,sim} - \tilde{t}_{fi} \|}{\| t_{fi,sim} \|} = 7.85\% \quad (2)$$

This polynomial function shows the interaction factors between the various parameters influencing the fire resistance of the connections. In

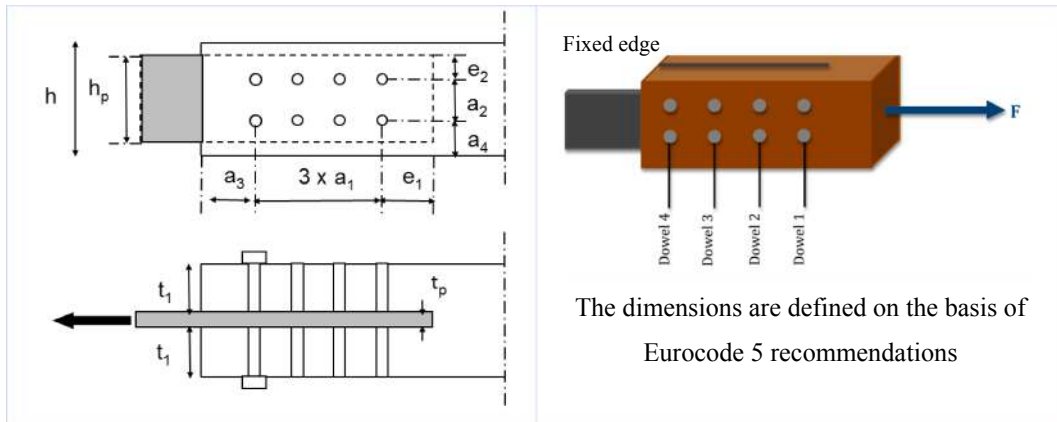

Fig. 9. Connection configuration chosen for the experimental design analysis (4×2 dowels).

Table 1
Experimental design parameters and simulated fire resistance durations.

N°	d mm	t ₁ mm	η % N _u	t _{fi,sim} min
1	12	55	10	33.1
2		55	30	18.4
3		75	10	48.0
4		75	30	18.4
5		95	10	57.2
6		95	30	31.8
7		115	10	62.0
8		115	30	42.6
9		135	10	79.6
10		135	30	37.0
11		160	10	90.0
12		160	30	42.9
13	16	55	10	32.3
14		55	30	15.3
15		75	10	42.8
16		75	30	24.6
17		95	10	56.7
18		95	30	35.4
19		115	10	68.0
20		115	30	45.0
21		135	10	80.0
22		135	30	43.3
23		160	10	81.8
24		160	30	44.0
25	20	55	10	31.7
26		55	30	15.2
27		75	10	43.2
28		75	30	23.2
29		95	10	48.3
30		95	30	31.8
31		115	10	63.0
32		115	30	43.0
33		135	10	75.5
34		135	30	45.0
35		160	10	90.0
36		160	30	40.5

fire situation, the interaction between the diameter of the fasteners and the timber member thickness is less significant than in normal condition of temperature (given the low level of loading, the fasteners do not yield) and could be neglected. The Eq. (1) becomes:

$$\tilde{t}_{fi} = 27.32 - 1.51d + 1.07t_1 - 7.51 \cdot \ln(\eta) + 0.49d \cdot \ln(\eta) - 0.24t_1 \cdot \ln(\eta) \quad (3)$$

With the mean relative error:

$$\|\varepsilon\| = \frac{\|t_{fi,sim} - \tilde{t}_{fi}\|}{\|t_{fi,sim}\|} = 7.87\% \quad (4)$$

To obtain a formula similar to that of EN1995-1-2, a transformation is done. By factorizing the logarithmic function, equation (Eq. (3)) can be written as follows:

$$\tilde{t}_{fi} = \ln[(\alpha_1 \cdot \alpha_2^d \cdot \alpha_3^{t_1}) \cdot (\alpha_4 \cdot \alpha_5^d \cdot \alpha_6^{t_1}) \ln \eta] \quad (5)$$

The coefficients α_1 to α_6 are given in Table 2 for dowelled steel-to-timber connections.

This formula could also be rewritten as:

$$\eta_{fi} = e^{\frac{t_{fi}/\ln(\alpha_1 \alpha_2^d \alpha_3^{t_1})}{\ln(\alpha_4 \alpha_5^d \alpha_6^{t_1})}} \quad (6)$$

Table 2
Values of the coefficients α_1 to α_6 .

α_1	α_2	α_3	α_4	α_5	α_6
7.327 * 10 ¹¹	0.221	2.915	5.476 * 10 ⁻⁴	1.632	0.787

Eq. (6) could be used to calculate the load-carrying capacity of the connection after a given period of fire exposure. Then, this design load-carrying capacity is deduced from the Eq. (7).

$$R_{d,fi} = \eta_{fi} \times R_k \quad (7)$$

It should be noted here that the load ratio determined for the fire tests used as a basis for the validation of the finite element numerical model correspond to the “real” load ratios, determined from the average load-carrying capacity of the connections obtained from tests under normal temperature conditions (3 tests for each configuration). In a design approach, these “real” load ratios are unknown. Thus, they need to be calculated from the characteristic load-carrying capacity R_k , according to EN1995-1-1. Since this calculated value is smaller than the real load-carrying capacity, the formulas proposed here incorporate safe load ratio values.

The Eqs. (3), (5) and (6) are obtained from the application of experimental design approach on numerical results given by the developed finite element model. This model was validated on the basis of some experimental results. To evaluate the quality of the formula (Eq. (5)), calibrated using experimental design approach based on finite element numerical results (Eq. (5)), it is applied to all experimental results available in the bibliography. The comparisons between the experimental results and the formula are presented and discussed in the Section 5. It can be observed that for nearly all timber connections considered, exposed to ISO fire, the simulated results are always in safety side and the curves fitting the experimental results and those calculated according to formula are nearly parallel. For that reason, as a first approach it has been decided to use the same formula for all connection types taking into account the influence of different connection types using a modification factor called k (see Table 3).

This factor was calibrated on the basis of the available experimental data. The values of this coefficient are summarized in Table 3. For connections loaded in tension with an angle between 0° and 45° or between 45° and 90°, interpolation may be carried out to obtain the appropriate value of k factor. In the case of connections made only with bolts, a bolt head protection or an arrangement with non-projecting bolt heads is recommended. In the absence of such protection, an additional reduction factor, deducted from the experimental results, taken equal to 25% may be applied.

Using equation (Eq. (5)), design abacuses can be drawn in function of the timber thickness (t_1) and the load ratio in fire (η). The graphical representations are obtained for a fixed diameter. Fig. 10 shows an example of these abacuses for a dowel diameter of 16 mm. It could be a practical way for the small companies to check the fire stability of various types of connections presented in this paper and designed according to EN 1995-1-1.

The simple formula proposed in Eq. (5) could be used to predict the fire resistance of timber connections with more accurate results than the actual standards. This formula is compared with all the experimental results available in literature in order to check its accuracy and define precisely its field of application.

Table 3
Values of the coefficient k.

Connection configuration and loading type	k
Steel-to-timber connections in tension parallel to grain	1
Timber-to-timber connections in tension parallel to grain	1.35
Steel-timber-steel connections in tension parallel to grain	0.40
Steel-to-timber connections in tension with an angle to grain of 90°	1.60
Steel-to-timber connections in tension with an angle to grain of 45° (steel plates are visible)	1.30
Steel-to-timber connections in bending	2.10
When only bolts are used without protection, k factor can be multiplied by 0.75	

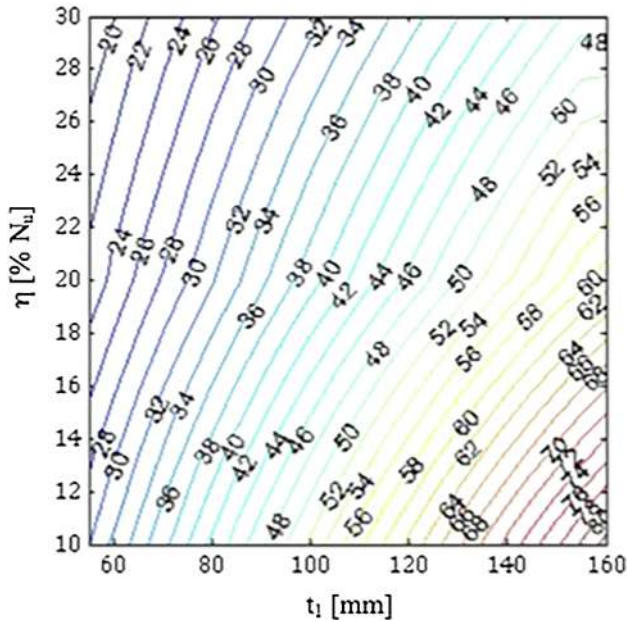

Fig. 10. Definition of fire resistance of a steel-to-timber connections with fastener diameter $d = 16$ mm.

5. Discussion on the proposed formula

In order to estimate the validity and accuracy of the proposed formula, it is applied to the connections tested in furnace to obtain the calculated fire resistance ($t_{fi,calc}$). These calculated values are compared to those from tests ($t_{fi,exp}$).

Thus, the formula was applied to most of the timber connections tested in the last 18 years in the world [1,7–15]. The results obtained by calculations using the proposed formula ($t_{fi,calc}$) are presented in Tables 4–7. In these tables, the calculated values of fire resistance according to the current method proposed by Eurocode 5-1-2 [4] are also presented ($t_{fi,EC5}$). The results given by formula are compared to those obtained from experiments.

5.1. Steel-to-timber connections loaded in tension parallel to grain

The experimental results (see Table 4) compared with those obtained by the proposed formula are taken from the following experimental programs: France 1999 [1], France 2003 [8,12], Switzerland 2004 [11], New-Zealand 2006 and 2007 [9,14] and Canada 2010 [15]. In the Canadian tests, the fire resistance values are low in comparison with those obtained from the other testing programs. This is due to the fact that these tests were conducted under a more severe fire than ISO fire. Indeed, differences between CAN/ULC-S101 [22,23] and ISO 834 tests exist due to different temperature measuring methods. Thus, the measured temperatures are lower resulting in more severe fire exposure

Table 4

Experimental and calculated fire resistance of steel-to-timber connections in tension parallel to grain.

	N°	Fasteners	ϕ (mm)	t_1 (mm)	η (%Nu)	$t_{fi,test}$ (min)	$t_{fi,calc}$ (min)	$t_{fi,EC5}$ (min)	
France 1999	8	2 × 4 bolts	20	60	37	22	17.7	23.8	
	8'				75	15	9.1	15.3	
	9	4 × 4 bolts	20		37	23	17.7	23.8	
	9'				73	16	9.5	15.7	
	10	2 × 2 bolts	12	50	46	17	10.6	18.8	
	10'				91	10	1.3	10.7	
	11	2 × 4 bolts	12		41	18	12.2	20.6	
	11'				83	11	2.6	12.7	
	12	4 × 4 bolts	12		40	18	12.5	21.1	
	12'				80	13	3.1	12.9	
	France 2003	A13d	2 × (1 bolt + 3 dowels))	16	76	30	36	23.6	18.4
		A		16	75	10	55.5	42.8	31.4
A'					20	41	30.5	23.2	
A''					30	36	23.3	18.4	
B			20		10	52	41.2	31.4	
B'					30	37	24.0	18.4	
C			12		10	54	44.3	31.4	
C'					30	39	22.7	18.4	
D			20	95	10	90	51.5	31.4	
D'					30	45	29.1	18.4	
Switzerland 2004	D01.1	9 × 2 dowels	6.3	37	30	33	12.2	–	
	D01.1'				15	36.3	21.4	–	
	D01.1''				7.5	41.3	30.6	–	
	D02.1	9 × 3 dowels			30	31.3	12.2	–	
	D03.1	3 × 3 dowels			30	32.5	12.2	–	
	D04.1	4 × 2 dowels	12	44	30	34.8	14.9	18.4	
New-Zealand 2006–2007	WSW1	1 bolt	12	45	34	16.5	13.5	17	
	WSW2	2 × 2 bolts			39	15.1	11.8	15.3	
	WSW3	5 bolts			38	16.5	12.2	15.7	
					10	14.5	24.8	31.8	
Canada 2010	1	1 × 2 bolts	12.7	38	10	14.5	24.8	31.8	
	1'				30	8.5	13.4	18.9	
	2	2 × 2 bolts	12.7	60	11	28	34.7	30.7	
	2'				18	22.5	27.0	24.9	
	2''				29	17.5	19.5	19.3	
	3	1 bolt	19.1		11	27	32.6	30.7	
	3'				32	15	19.2	18.1	
	4	2 × 2 bolts	19.1		10	26	33.8	31.8	
	4'				30	14	20.0	18.9	
	5	2 × 2 bolts	19.1	80	10	36.5	44.1	31.8	
5'				29	19	25.7	19.3		

Table 5

Experimental and calculated fire resistances of timber-to-timber connections loaded in tension parallel to grain.

	N°	Fasteners	ϕ (mm)	t_1 (mm)	η (%Nu)	$t_{fi,test}$ (min)	$t_{fi,calc}$ (min)	$t_{fi,EC5}$ (min)
France 1999	1	2 × 4 bolts	20	60	47	24	14.8	24.1
	1'				94	15	6.4	13.7
	2	2 × (1 bolt + 3 dowels)	20		48	35	19.2	36.8
	4	4 × (1 bolt + 3 dowels)	20		31	38	19.8	48.1
	4'				62	23	11.4	30.8
	5	2 × 4 bolts	12	50	36	22	13.9	27.5
France 2003	5'				84	13	2.4	14.2
	6	2 × (1 bolt + 3 dowels)	12		39	32	12.8	40.9
	6'				77	13	3.6	23.6
	A	2 × (1 bolt + 3 dowels)	16	64	10	59.5	37	66.6
	A'				20	45.5	26.7	49.3
	A''				30	39.5	20.6	39.2
New-Zealand 2006–2007	B			84	10	79	47.4	66.6
	B'				30	54	25.6	39.2
	WWW1	1 bolt	12	45	33	20.5	13.9	22.6
	WWW2	5 bolts			39	20.3	11.9	20.1
	WWW3	3 × 2 bolts			44	17.5	10.4	18.2

Table 6

Experimental and calculated fire resistances of steel-timber-steel connections loaded in tension parallel to grain.

	N°	Fasteners	ϕ (mm)	t_1 (mm)	η (%Nu)	$t_{fi,test}$ (min)	$t_{fi,calc}$ (min)	$t_{fi,EC5}$ (min)
New-Zealand 2006–2007	SWS1	1 bolt	12	63	28	7.4	20.8	19.2
	SWS2	2 × 2 bolts			20	10.6	19.6	18.4
	SWS3				38	8.8	15.7	15.6
Canada 2010	1	2 × 2 bolts	12.7	80	10	14	46.6	30.7
	1'				30	8.5	24.1	17.8
	2	2 × 2 bolts	19.1	130	10	23.5	70	30.7
	2'				19	15.5	51.2	23.2

Table 7

Experimental and calculated fire resistances of steel-to-timber connections loaded in tension with an angle to the grain (France – 2010).

	N°	Fasteners	ϕ (mm)	t_1 (mm)	η (%Nu)	$t_{fi,test}$ (min)	$t_{fi,calc}$ (min)	$t_{fi,EC5}$ (min)
Tension with an angle of 90°	A1	2 × 2 dowels	16	77.5	10	71	44.1	31.4
	A2				30	48	24.0	18.4
	A3		20	105	30	69	31.6	18.4
	A4				45	62	22.3	13.7
Tension with an angle of 45°	B1		16	77.5	10	69	44.1	31.4
	B2				30	35	24.0	18.4
	B3		20	105	30	62	31.6	18.4
Bending	C1	3 × 2 dowels	16	77.5	12	88	40.7	29.2
	C2				38	61	19.7	15.7
	C3				38	55	19.7	15.7
	D1	2 × 3 dowels			38	58	19.7	15.7
	D2				38	52	19.7	15.7
	D3				45	50	16.6	13.7

than a standard test controlled by bare thermocouples, especially in the first 10 min. This phenomenon seems to be confirmed by the values of charring rates of timber measured at the end of these tests which are significantly higher than those measured during the other experimental programs [15].

Moreover, it should be noted that, for fire tests conducted in France in 1999, no tests were conducted in normal conditions to determine the real load carrying capacity of the connections. These load capacities were determined using Eurocode 5, taking into account an effective number of fasteners. Thus, the load ratio used for fire tests were not the real load ratio determined by tests. As these calculated load ratios are higher than the real ones and thus, the calculated fire resistances are lower.

These results are also presented in Fig. 11.

Except for tests carried out in Canada in 2010, the fire resistance times calculated with the proposed formula are, as for timber-to-timber connections, always lower than the experimental values. For the tests

carried out in France (1999), in New Zealand (2006) and in Canada (2010), the calculations made using the EN1995-1-2 method overestimates the fire resistance values of the tested specimens.

The average relative error between calculated and experimental values for steel-to-timber connections is about 20%. This error is acceptable as part of a safe design approach. It should be noted that this error is greater for the tested specimens with the smallest fire resistance values (connections 10', 11' and 12' of the French experimental program of 1999).

Concerning the tests carried out in Switzerland in 2004, the fire resistance calculated by the EN1995-1-2 methodology is closer to the experimental values than those calculated with the proposed formula. Paradoxically, the method proposed by Eurocode would theoretically not be applicable in the case of these tests which are outside the scope of the method due to the small diameter of the dowels, less than 12 mm (6.3 mm).

By comparing the curves obtained by the values calculated using the

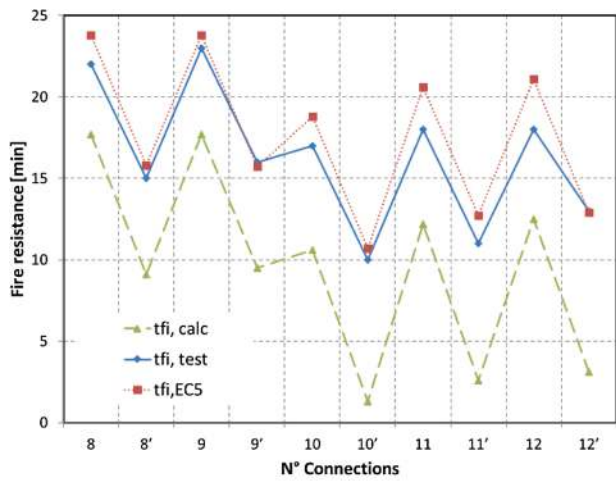

a) France - 1999

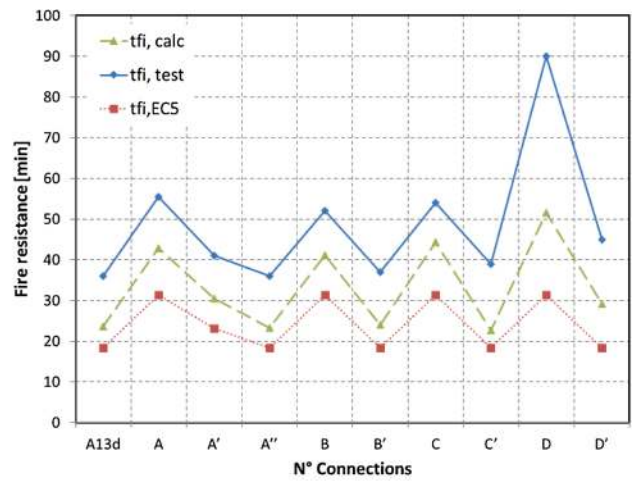

b) France - 2003

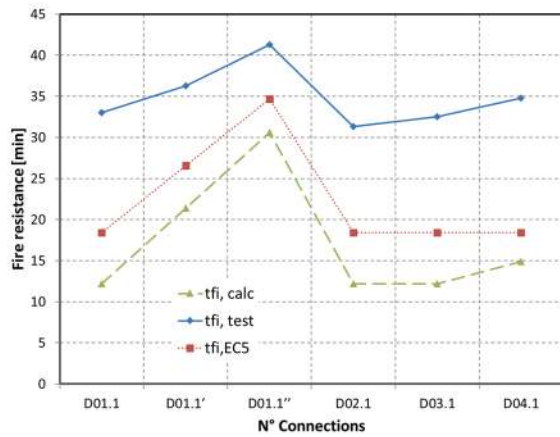

c) Switzerland - 2004

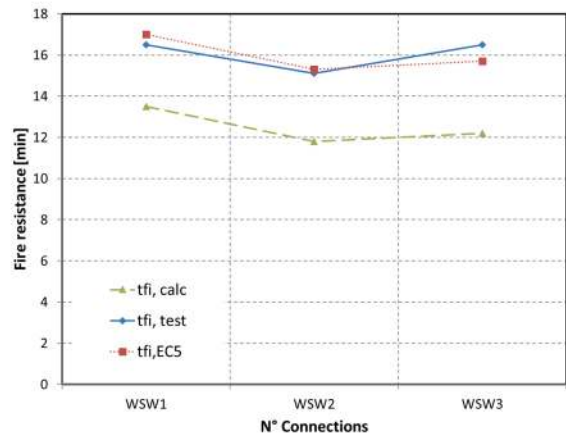

d) New-Zealand 2006-2007

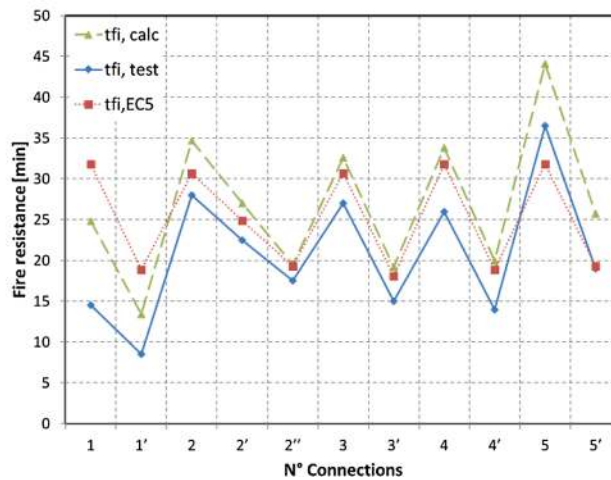

e) Canada 2010

Fig. 11. Experimental and calculated fire resistances of steel-to-timber connections loaded in tension parallel to grain.

proposed formula and those obtained from the experimental values, it is clear that the shape of these curves is very close, with a quasi-constant gap. This illustrates the accuracy of the formula and its ability to follow the experimental values whatever the experimental conditions and the configurations tested.

For steel-to-timber connections loaded in tension parallel to grain, a

value of the modifying factor k equal to 1 is conservative (Table 3). In fact, the fire resistance value given by the numerical model represents the initiation phase of failure and not the ultimate stage. From the experimental observations, it appears that the connections resisted few minutes after the initiation of failure.

The value of the factor k for these types of connections could be

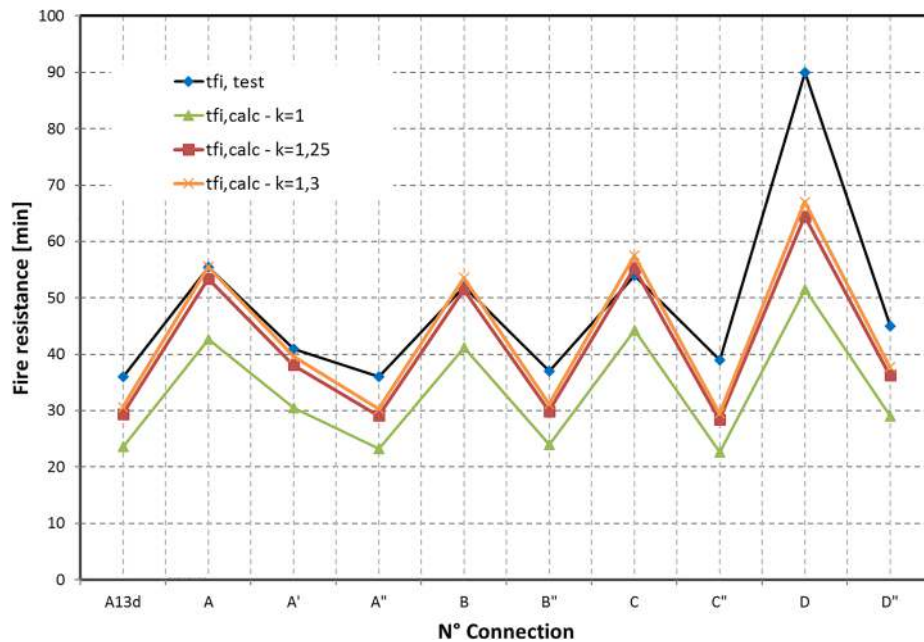

Fig. 12. Experimental and calculated fire resistances of steel-to-timber connections loaded in tension parallel to grain with variation of the k factor value.

increased to 1.25 or 1.3 in order to approximate the experimental results. This choice, as well as the other values of k proposed, must be discussed depending on the desired level of safety factor. Moreover, in the future, these values could be readjusted according to new experimental results.

As an example, Fig. 12 presents the different results for the tests realized in France in 2003 by varying the value of the modifying factor k from 1 to 1.3.

As shown in Fig. 12, depending on the chosen safety factor, the fire resistance defined by the proposed formula could be easily modified with corresponding modification of k factor.

Fig. 13 shows the dispersion of the calculated and measured values as a function of the k factor value.

5.2. Timber-to-timber connections loaded in tension parallel to grain

The experimental results (Table 5) are taken from the following experimental programs: France 1999 [1], France 2003 [8,12], New-Zealand 2006 and 2007 [10,11]. As for steel-to-timber connection, for fire tests conducted in France in 1999, no tests were conducted in normal conditions to determine the load carrying capacity of the connections.

These results are also presented in Fig. 14.

It can be seen from Fig. 14 that the fire resistances calculated according to the proposed formula are always lower than the experimental ones, whereas those calculated using EN1995-1-2 overestimate in most cases the experimental values. The difference between the values calculated according to the proposed formula and those obtained by tests is mainly due to the method used to determine the numerical fire resistance durations on the basis of numerical curves (see Section 3.2 and Fig. 6).

The average relative error between the values calculated using the proposed formula and those obtained from tests is about 28%. This relative error is essentially the same for the two experimental programs carried out in France in 1999 and 2003 and the 3 fire tests conducted in New Zealand.

5.3. Steel-timber-steel connections loaded in tension parallel to grain

The experimental data are taken from the following experimental

campaigns: Canada 2010 [15], New-Zealand 2006 and 2007 [9,14], see Table 6.

The results are also presented in Fig. 15.

For these connections, Fig. 15 shows that the EN1995-1-2 method is not relevant. Indeed, the fire resistance values overestimate significantly the fire resistances of the tested connections.

The fire resistance of this type of connections is conditioned by the small thickness of timber involved (a single central timber member).

Using a k factor of 0,4 with the proposed formula (Table 3), the results can represent well the experimental values. For the connections tested in New-Zealand (Fig. 15a), the mean relative error is close to 25%. For the connections tested in Canada (Fig. 15b), three calculated fire resistance values remain slightly higher than the experimental values. However, it should be remembered that these tests were performed with a more severe fire than an ISO fire exposure.

This result must be validated by comparison with a greater number of experimental values.

5.4. Steel-to-timber connections loaded in tension with an angle to the grain and in bending

The experimental data are taken from the following experimental programs: France 2010 [7], see Table 7.

The results are also presented in Fig. 16.

Fig. 16 shows that the EN1995-1-2 method is not relevant for connections loaded with an angle to grain. The application of the proposed formula shows that the fire resistance values are lower than the experimental values. However, it should be noted that in this case too, the curves obtained from the calculated values follow well the curve shape obtained from the experimental values. The correction factor k depending on the angle of load is used here to refine the precision of the proposed formula. Thus, using a factor k depending on the angle of the load equal to 1,6 for tension with an angle to grain of 90°, 1,3 for tension with an angle of 45° and 2,1 for bending, fire resistance durations reach a good accordance with the experimental ones (Fig. 16). The mean relative errors are respectively equal to 22%, 20% and 23%.

5.5. Dispersion of results

Fig. 17a shows the dispersion of the calculated and measured values

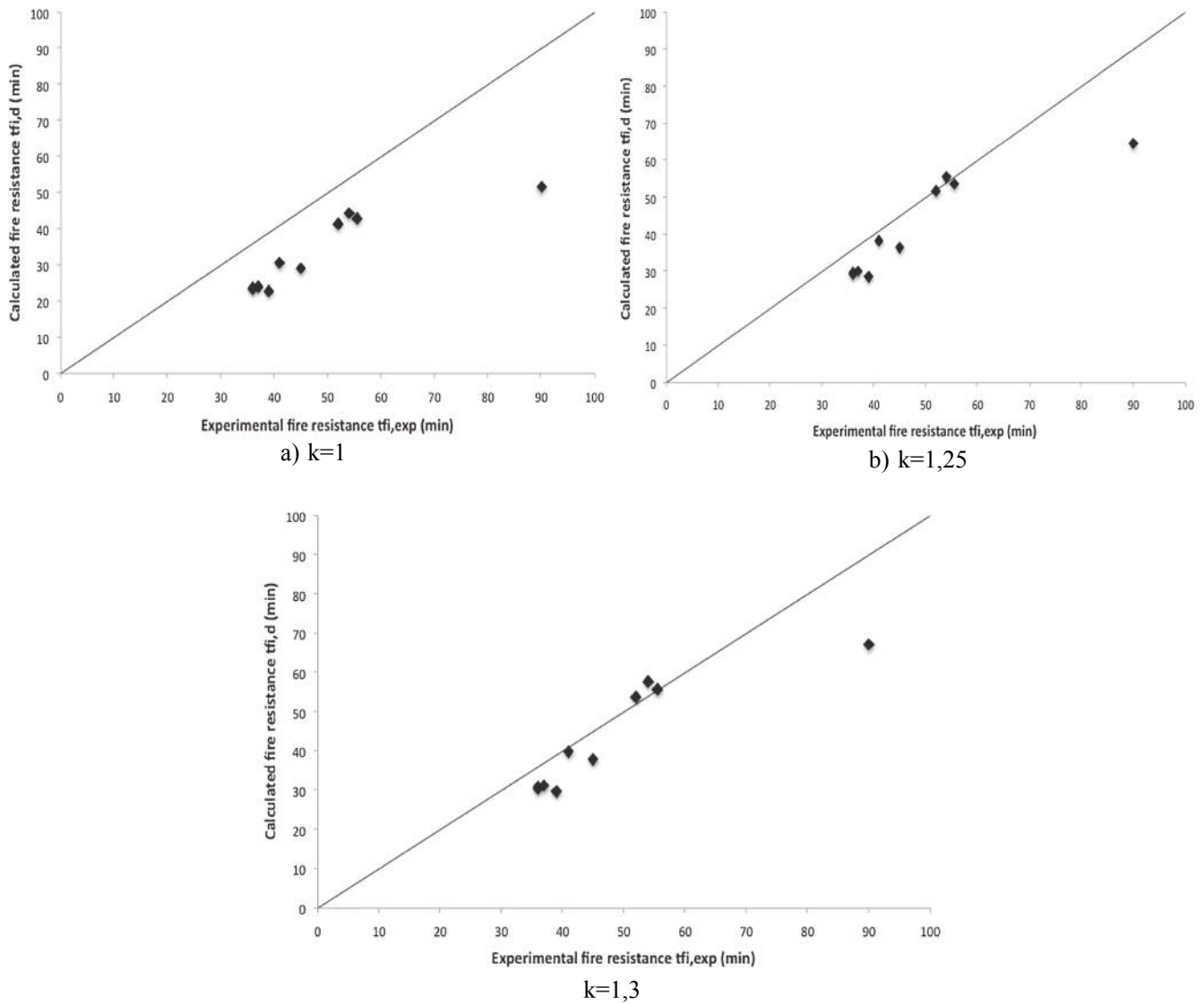

Fig. 13. Dispersion of the calculated and measured values of fire resistance for steel-to-timber connections with different k factors (France – 2003).

for all the tested connections presented in the paper (except the Canadian tests of 2010 which should be recalibrated according to the ISO curve). For this figure, the factor k of connections loaded in tension parallel to grain is taken equal to 1 (conservative value).

Fig. 17b shows the dispersion of the calculated and measured values for all the tested connections presented in this paper (Canadian tests of 2010 included). For this figure too, the factor k is taken equal to 1.

To evaluate the existing standard (EN1995-1-2), its results are compared with the experimental ones considering all the experimental results available. The comparison shows a large dispersion of results (Fig. 18a) with $R^2 = 0.158$ for the linear regression. The proposed method is also compared with the experimental results considering the appropriate values of k factor (according to table 3) (Fig. 18b) or modified value for steel-to-timber connections ($k = 1.25$ instead of 1) except for the Canadian fire tests that used a fire curve more severe than ISO curve. With the proposed method, the results are more accurate in comparison with the experimental results.

The comparisons show that the proposed method allows to obtain accurate and safe values of fire resistance for all the tested connections. Moreover, the curves obtained with the formula follow the linear regression of the results representing the calculated resistance versus the experimental one. The coefficients of determination R^2 are higher than 0.8 (Fig. 18b and c), confirming the ability of the model to represent the

physical phenomena.

6. Conclusions

This paper presents a new formula to predict the fire resistance of connections in timber structures. This method is developed from an experimental design approach based on finite element results. It is validated on the basis of a significant number of fire tests carried out on various types of dowelled timber connections.

The various existing experimental programs carried out on timber connections under fire exposure and the main assumptions used for the development of the numerical model are presented. Then, the proposed formula is used to predict the fire resistance of most of the timber connections tested in recent years in the world.

The comparison of the results shows that the proposed method makes it possible to obtain safe fire resistance values and therefore more accurate than those obtained with the current method of Eurocode (except for tests carried out in Canada but exposed to a thermal action more severe than ISO fire exposure). The differences between the predicted values and the experimental values vary according to the type of connection and the load applied. More importantly, the proposed formula makes it possible to obtain curves of fire resistance which follow well the shape of the experimental curves.

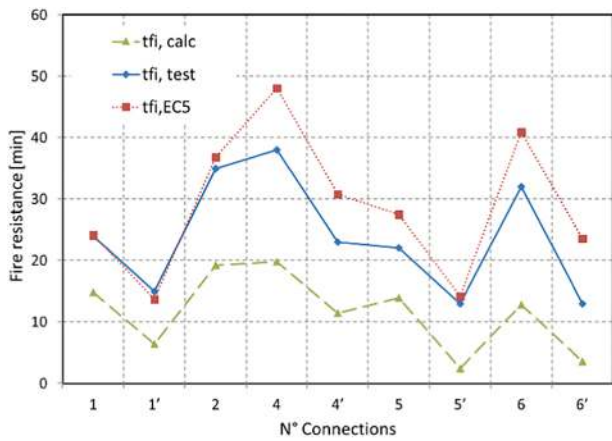

a) France - 1999

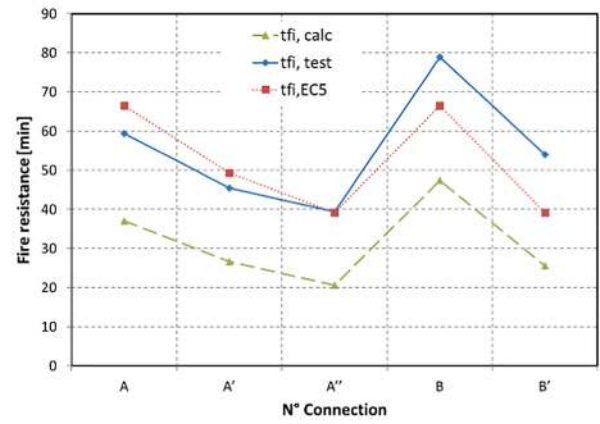

b) France - 2003

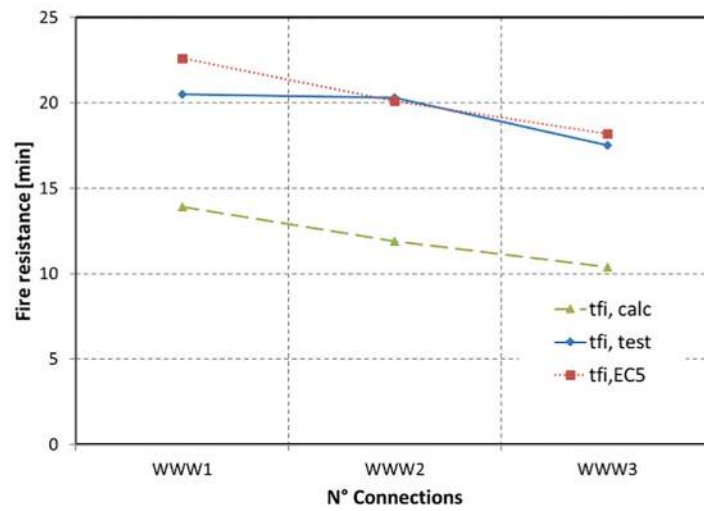

c) New-Zealand 2006-2007

Fig. 14. Experimental and calculated fire resistances with k factor of timber-to-timber connections loaded in tension parallel to grain.

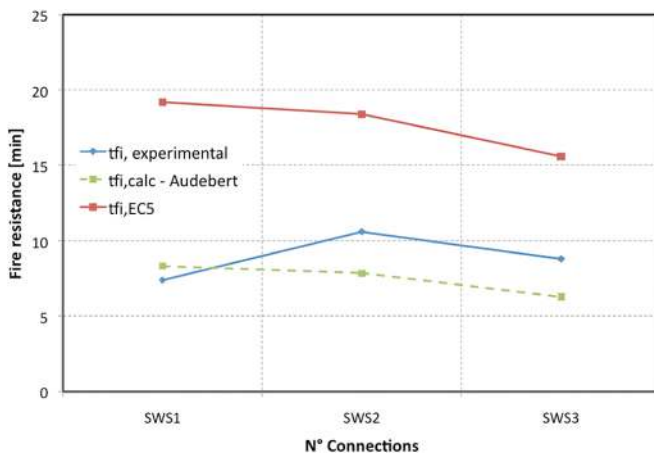

a) New-Zealand - 2006-2007

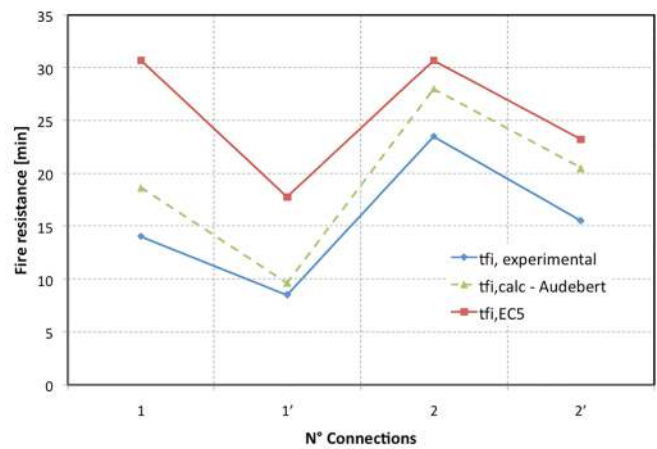

b) Canada - 2010

Fig. 15. Experimental and calculated fire resistances of steel-timber-steel connections loaded in tension parallel to grain.

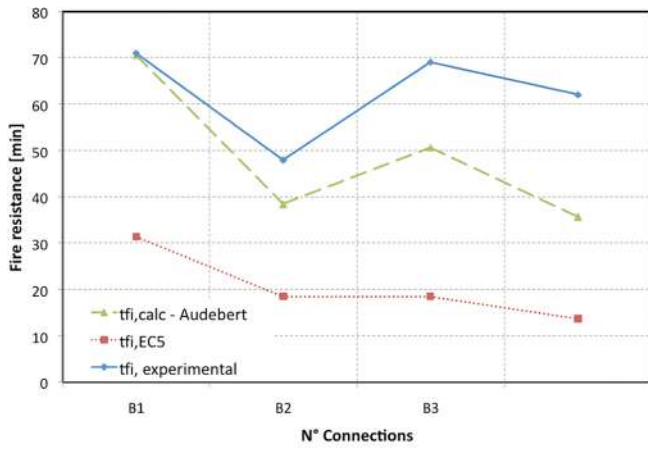

a) Tension with an angle to grain of 90°

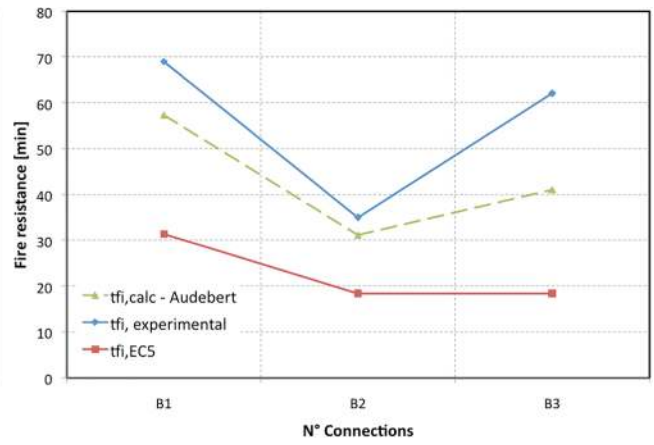

b) Tension with an angle to grain of 45°

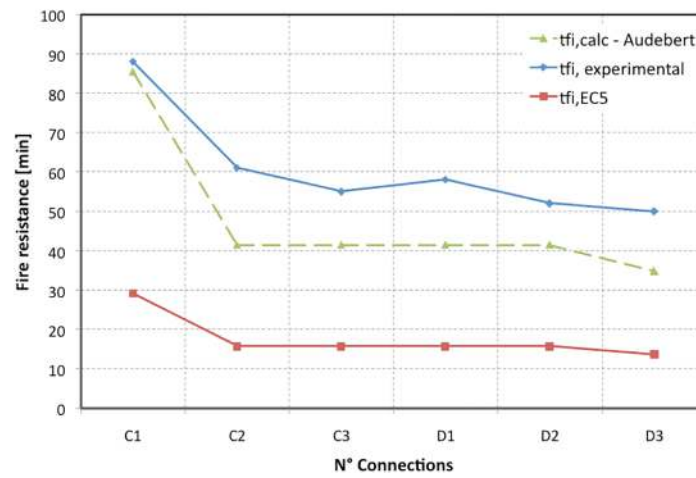

c) Bending

Fig. 16. Experimental and calculated fire resistances of steel-timber-steel connections loaded in tension with an angle to grain and in bending.

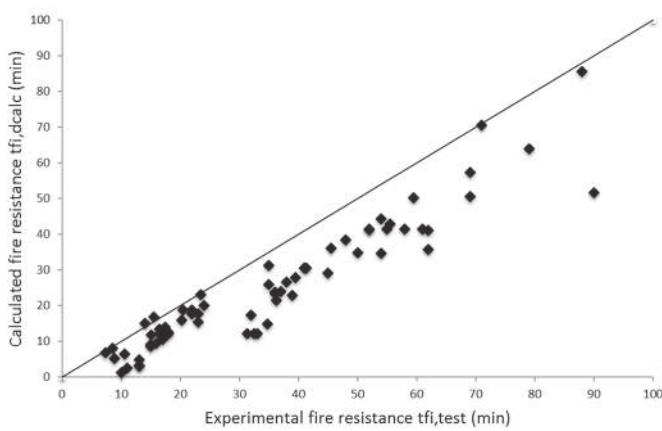

a- Without the Canadian tests of 2010

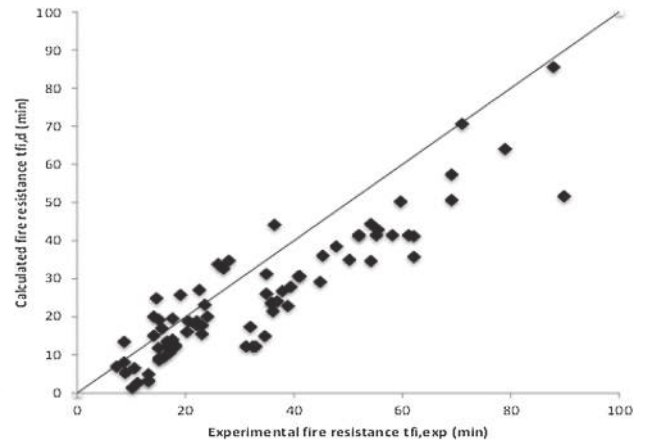

b- With the Canadian tests of 2010

Fig. 17. Dispersion of the calculated and measured values of fire resistance.

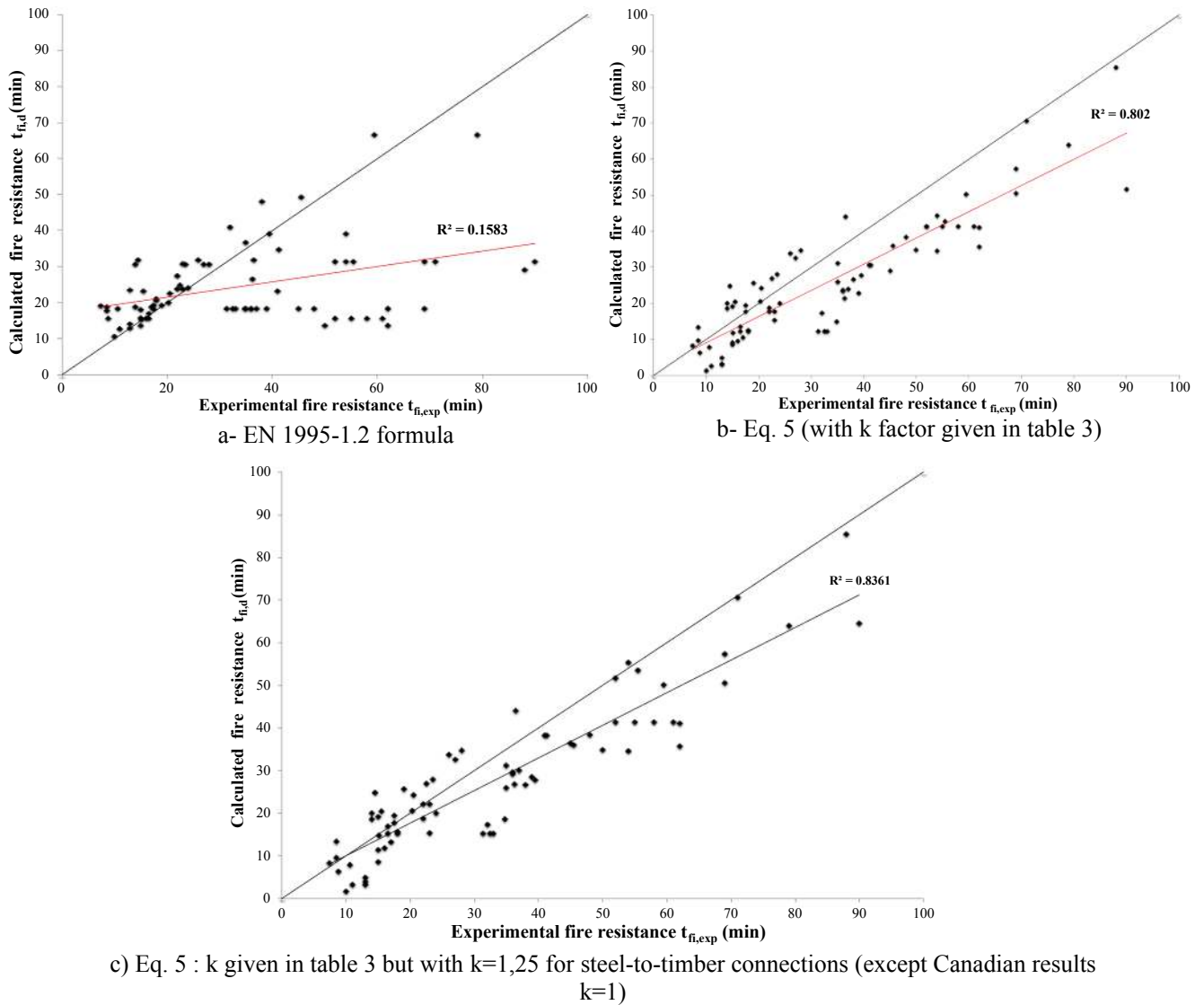

Fig. 18. Fire resistance calculated according to three methods versus experimental results.

This proves the capacity of the developed formula to reproduce the physical phenomena specific to the fire behavior of the connections, regardless of the connection configurations, the materials used and the nature of the load applied.

The proposed formula was developed on the basis of steel-to-timber connections loaded in tension parallel to grain, which is the more unfavorable in fire situation. For timber-to-timber connections, steel-timber-steel connection and connections loaded with an angle to grain, as the tendency is similar between the experimental and calculated values, the use of modification factors on the formula makes it possible to obtain fire resistance values in good accordance with the experimental ones, with a safety margin of about 20%. This method also makes it possible to guarantee fire resistance values greater than 30 min, which is currently the validity limit of the method proposed by Eurocode. This limit is currently very penalizing for the design of

timber constructions.

The method presented here is a first proposal to predict the fire resistance of timber connections in a more precise way than the current existing approaches. It is currently under further investigations which will make it possible to refine the precision of the results obtained through the factor k.

The proposed method, which is simple to apply, can be used by engineers to design timber connections under fire exposure, with greater accuracy than current standards.

Declaration of Competing Interest

The authors declare that they have no known competing financial interests or personal relationships that could have appeared to influence the work reported in this paper.

Appendix A. Main characteristics of the numerical 3D model used as reference to generate the data used in the study

Hoffman criterion (adaptation of Tsai-Wu criterion)

$$[C_1(\sigma_y - \sigma_z)^2 + C_2(\sigma_z - \sigma_x)^2 + C_3(\sigma_x - \sigma_y)^2 + C_4\sigma_x + C_5\sigma_y + C_6\sigma_z + C_7\tau_{yz}^2 + C_8\tau_{xz}^2 + C_9\tau_{xy}^2] \leq 1$$

With:

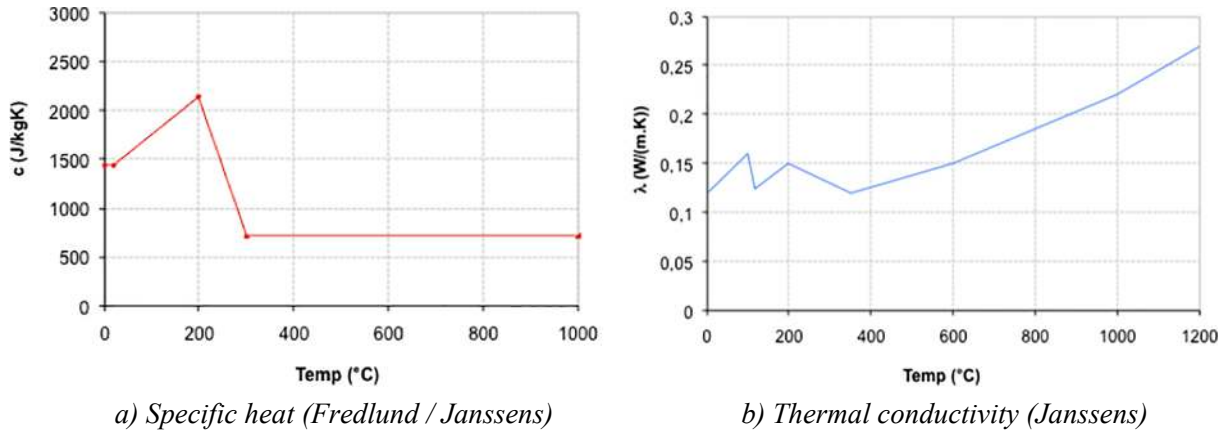

Fig. A1. Evolution of the thermo-physical properties of timber.

$$C_1 = \frac{1}{f_{i,90}f_{c,90}} - \frac{1}{2f_{i,0}f_{c,0}}; C_2 = C_3 = \frac{1}{2f_{i,0}f_{c,0}}; C_4 = \frac{1}{f_{i,0}} - \frac{1}{f_{c,0}};$$

$$C_5 = C_6 = \frac{1}{f_{i,90}} - \frac{1}{f_{c,90}}; C_7 = C_8 = C_9 = \frac{1}{f_v^2}$$

Hill criterion

$$\bar{\sigma} = [a_1(\sigma_y - \sigma_z)^2 + a_2(\sigma_z - \sigma_x)^2 + a_3(\sigma_x - \sigma_y)^2 + 3a_4\tau_{zx}^2 + 3a_5\tau_{yz}^2 + 3a_6\tau_{xy}^2]^{1/2}/\sqrt{2}$$

$$\text{with } a_1 = \frac{2}{f_{c,90}^2} - \frac{1}{f_{c,0}^2}; a_2 = a_3 = \frac{1}{f_{c,0}^2}; a_4 = a_5 = a_6 = \frac{2}{3f_v^2}.$$

where:

σ_i, τ_{ij} the axial and shear stresses;

$f_{c,0}; f_{c,90}$ Compressive strengths in the directions parallel and perpendicular to grain;

f_v : Shear strength (see Figs. A1–A4 and Table A1).

Appendix B. Current approach of Eurocode 5 (EN1995-1-2) to predict the fire resistance of timber connections

EN1995-1-2 provides a general method, the “Reduced Load Method”, to design the timber connections under a standard fire exposure. Then, for standard fire exposure, the characteristic load-carrying capacity of a connection with fasteners in shear should be calculated as:

$$F_{V,Rk,fi} = \eta \cdot F_{V,Rk} \quad (1)$$

with

$$\eta = e^{-k \cdot t_{d,fi}} \quad (2)$$

where η is a reduction factor, k is a parameter depending on the connection and fasteners type, $t_{d,fi}$ is the design fire resistance of the unprotected connection, in minutes. This design fire resistance of the connection with mechanical design load considered in fire situation should be taken as given by Eq. (3).

$$t_{d,fi} = -\frac{1}{k} \ln \frac{\eta_{fi} \cdot \gamma_{M,fi}}{\gamma_M \cdot k_{fi}} \quad (3)$$

where η_{fi} is the reduction factor for design load in fire situation (ratio of load in fire situation to load in normal situation); γ_M is the partial factor for the connection; $\gamma_{M,fi}$ is the partial safety factor for timber in fire (the recommended value is $\gamma_{M,fi} = 1$); k_{fi} is a parameter depending on the connection type.

This calculation method has a limited range of application (not more than 30 or 40 min according to the connection type) due to the lack of data.

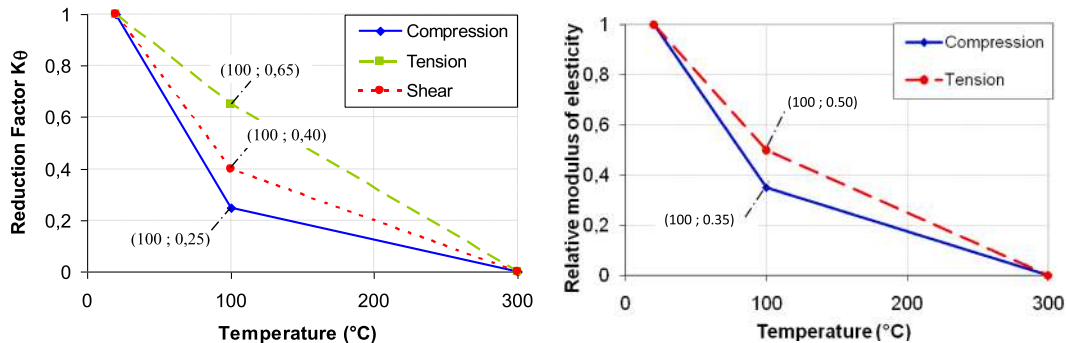

Fig. A2. Reduction factors of resistance and modulus of Elasticity (resinous wood, direction parallel to grain).

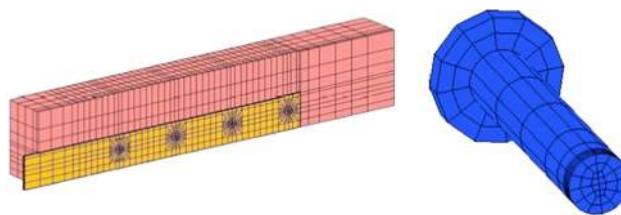

Fig. A3. Meshing for the mechanical model (normal conditions).

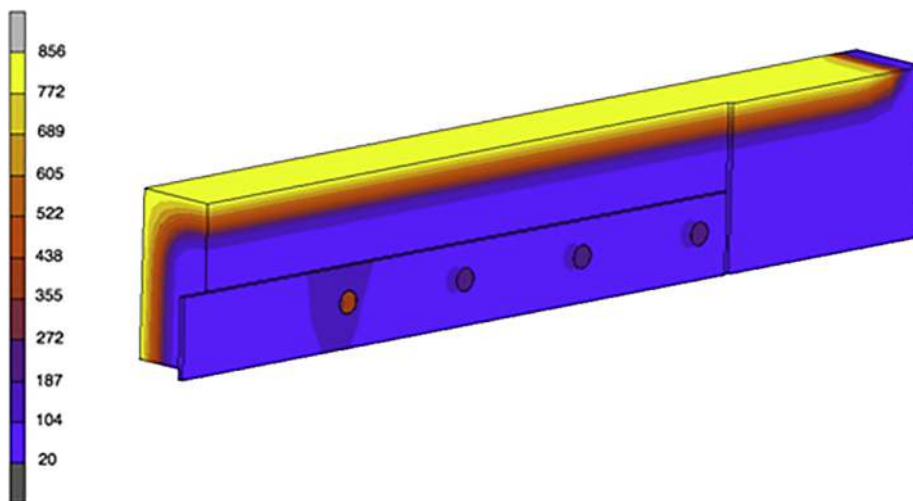

Fig. A4. Example of thermal model (after 30 min of exposure).

Table A1

Material characteristics used in the numerical modelling for timber.

E_0 (MPa)	E_{90} (MPa)	G (MPa)	$\nu_{LR} = \nu_{RT}$	ν_{TL}	ρ (kg/m ³)	$f_{c,0}$ (MPa)	$f_{c,90}$ (MPa)	f_v (MPa)
12,600	420	780	0.41	0.02	450	50.64	3.14	10.98

References

- [1] Dhima D. Vérification expérimentale de la résistance au feu des assemblages d'éléments en bois. CTICM 1999:61.
- [2] Buchanan AH. Fire performance of timber construction. Prog Struct Mat Eng 2000;2(2):278–89.
- [3] König J, Fontana M. The performance of timber connections in fire-test results and rules of Eurocode 5. In: Proceedings of the International RILEM Symposium 2001; Aicher A, Reinhardt HW. RILEM publications; 2001. p. 639–48.
- [4] EN 1995-1-2: 2004, Eurocode 5. Design of timber structures. Part 1-2 : General rules - Structural fire design. CEN TC 250-SC5, Brussels, 2004.
- [5] König J. Calculations vs fire testing – limitations of Eurocode 5 and the need of fire testing. In: International Symposium on advanced timber and timber-composite elements for building: 27–29; 2004.
- [6] Audebert M, Dhima D, Taazount M, Bouchaïr A. Numerical investigations on the thermo-mechanical behaviour of steel-to-timber connections exposed to fire. Eng Struct 2011;33:3257–68.
- [7] Audebert M. Approche expérimentale et modélisation du comportement au feu d'assemblages bois sous différents types de sollicitations. PhD Thesis, Université Blaise Pascal Clermont-Ferrand and CSTB, 233p; France; 2010.
- [8] Ayme N, Joyeux D. Comportement au feu d'assemblages bois. Assemblages bois-métal en double cisaillement. Rapport SRI-0.3/121-NA/PB n°030156, CTICM; 2003. 62 p.
- [9] Chuo TCB. Fire performance of connections in Laminated Veneer Lumber. Fire Engineering Research Report 07/3, 2007. MEFE Thesis. University of Canterbury, Department of Civil Engineering.
- [10] Erchinger C. Zum Verhalten von mehrfchnittigen Stahl-Holz-Stabübelverbindungen im Brandfall. PhD Thesis. ETH Zürich; 2009.
- [11] Frangi A, Mischler A. Fire tests on timber connections with dowel-type fasteners. Proceedings of CIB-W18, paper 37–16-2, Edinburgh, Scotland. 2004.
- [12] Laplanche K. Comportement au feu des assemblages bois – Assemblages Bois/bois et Bois/métal en double cisaillement, Rapport d'étude DSSF-ISTA/KL/MT/ER0200511, CSTB; 2003. 40p.
- [13] Laplanche K. Etude du comportement au feu des assemblages de structures bois: Approche expérimentale et modélisation. PhD Thesis, Université Blaise Pascal Clermont-Ferrand et CSTB, France; 2006. 140p.
- [14] Lau PH. Fire resistance of connections in Laminated Veneer Lumber (LVL). Fire Engineering Research Report 06/3, May 2006. MEFE Thesis. University of Canterbury, Department of Civil Engineering.
- [15] Peng L. Performance of heavy timber connections in fire. PhD Thesis, Ottawa-Carleton Institute of Civil and Environmental Engineering, Canada; 2010. 235p.
- [16] Audebert M, Dhima D, Taazount M, Bouchaïr A. Experimental and numerical analysis of timber connections in tension perpendicular to grain. Fire Saf J 2014;63:125–37.
- [17] MSC.Marc User's manual. Vol. A: theory and user information. MSC.Software Corporation; 2005.
- [18] EN 1993-1-2: 2005, Eurocode 3. Design of steel structures. Part 1–2: General Rules — Structural fire design. Brussels; 2005.
- [19] Janssens M. Thermo-physical properties for wood pyrolysis models. Pacific Timber Engineering Conference Gold Coast, Australia. 1994.
- [20] Fredlund B. Modelling of heat and mass transfer in wood structures during fire. Fire Saf J 1993;20:39–69.
- [21] Audebert M, Dhima D, Taazount M, Bouchaïr A. Thermo-mechanical behaviour of timber-to-timber connections exposed to fire. Fire Saf J 2013;56:52–64.
- [22] CAN/ULC-S101. Standard methods of fire endurance tests of building construction and materials. Scarborough, Canada: Underwriter's Laboratories of Canada; 2007.
- [23] Sultan M. Fire resistance furnace temperature measurements: plate thermometer vs. shields thermocouples. Fire Technol 2006;42:253–67.